

FI SERIES CONNECTORS

1.25mm (.049") Pitch Connector for PCB-to-Cable

SINGLE ROW

Board Side Receptacle

Right Angle
Standard Mount Shielded
FI-S***P-HFE



Note: Shielding only available in 20 position.

Right Angle
Reverse Mount Shielded
FI-SEB20P-HFE



Type	Size
HF	1.48 (.058)
HF13	1.3 (.051)
HF10	1.0 (.039)

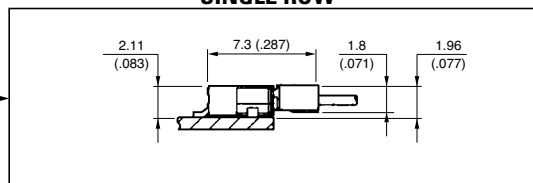

Cable Side Plug
Discrete Wire Unshielded
FI-S***S

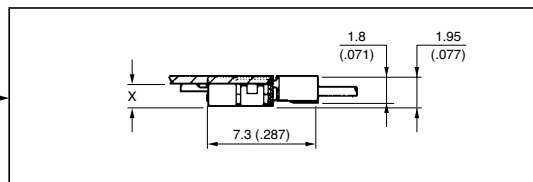

Socket Contact
FI-C3-A1-15000

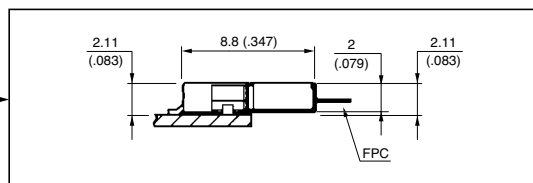
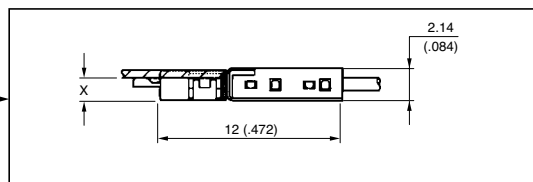
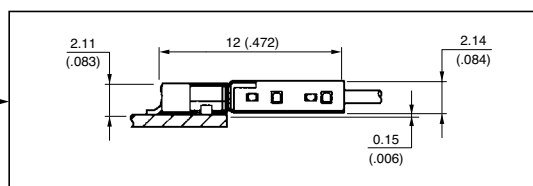
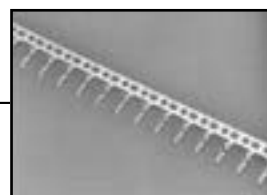

Standard Shielded
FI-SE20ME

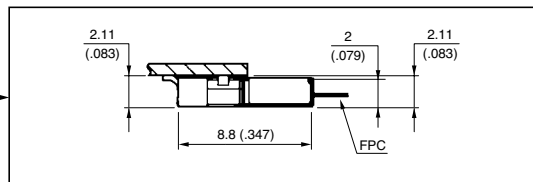
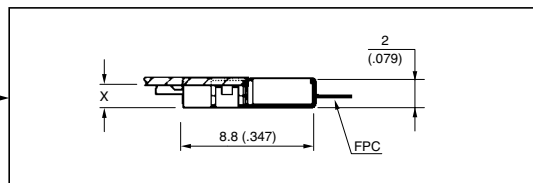

FPC-Reverse
FI-SE20MR

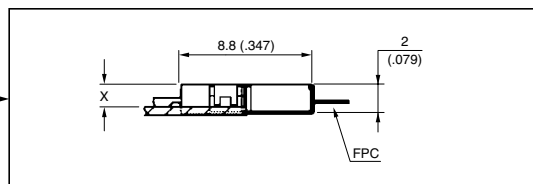

• Please consult JAE for verification of product availability.

Dimensions and specifications subject to change without notice.

FI SERIES CONNECTORS

1.25mm (.049") Pitch Connector for PCB-to-Cable DOUBLE ROW

Board Side Receptacle

Right Angle, Unshielded
21, 31, 41 Sizes
FI-W*P-HFE



Right Angle, Shielded
21, 31, 41 Sizes
FI-WE*P-HFE



Straight, Shielded
21, 31 Sizes
FI-TWE*P*-VFE



Cable Side Plug

Discrete Wire, Shielded
21, 31, 41 Sizes
FI-W*S



Socket Contact
FI-C3-A1-15000



FPC Right Angle, Shielded
21, 31 Sizes
FI-WE*M



FPC Straight, Shielded
21, 31 Sizes
FI-WE*MV

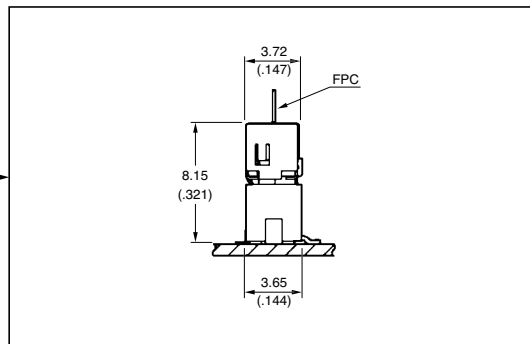
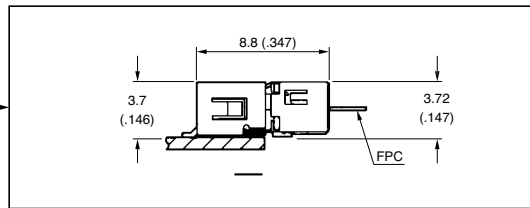
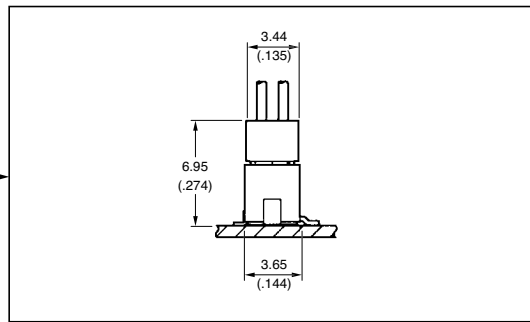
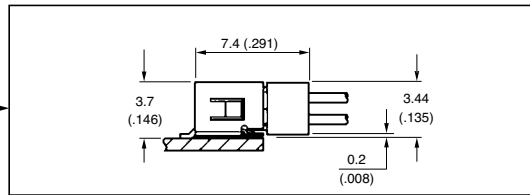
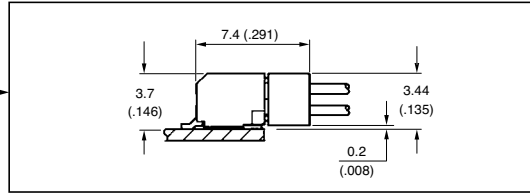

• Please consult JAE for verification of product availability.

Dimensions in mm (inches).